

Data Sheet



Article number: 390204400712836

Description: Worm Gear with Torque Limiter
VF 44-L2-N-7-P71B14

Measures

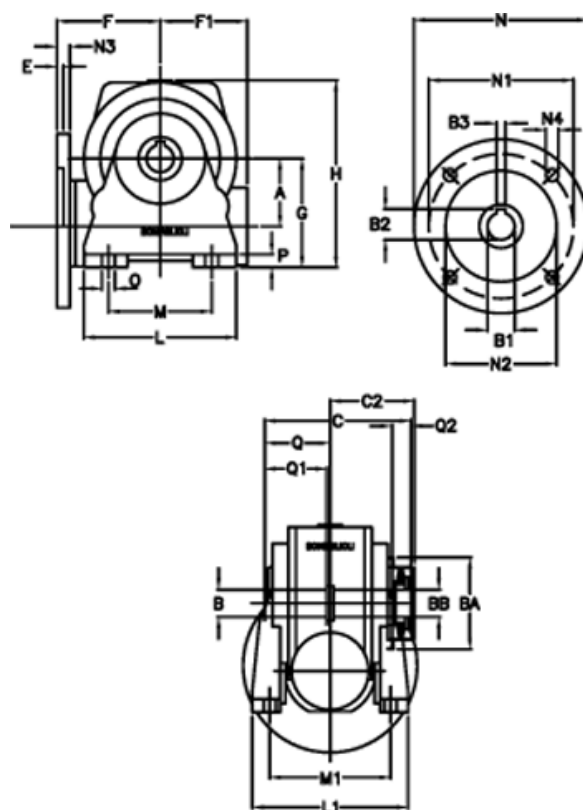

a = 44.60	C2 = 48	L1 = 98	O = 8.5
B = 18	Description = VF 44N-xx-71B14	m = 52	P = 10
B1 E7 = 14	E = 2.0	M1 = 81.0	Q = 32.0
B2 = 16.3	F = 65	N = 105	Q1 = 32
B3 H9 = 5	F1 = 54	N1 = 85	Q2 = 12
BA = 40	g = 72	N2 = 70	
BB H7 = 11	H = 124.5	N3 = 10.0	
C = 79	L = 90	N4 = 7	